

Fig. 1

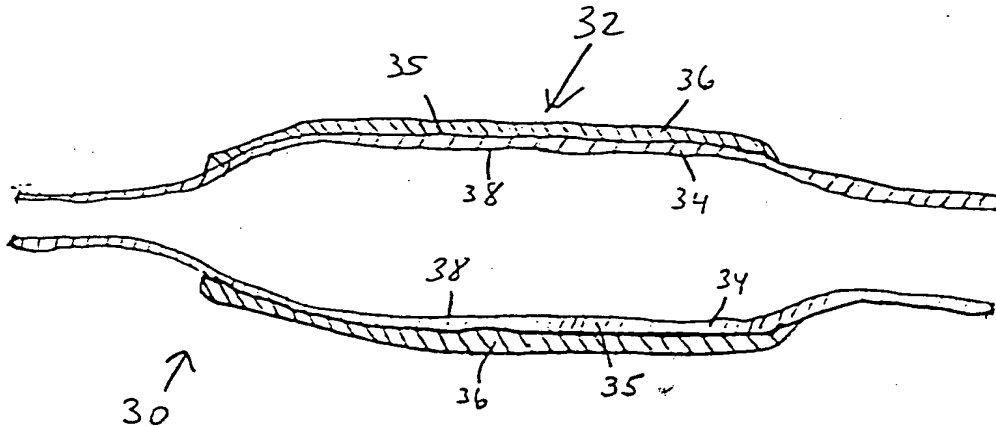
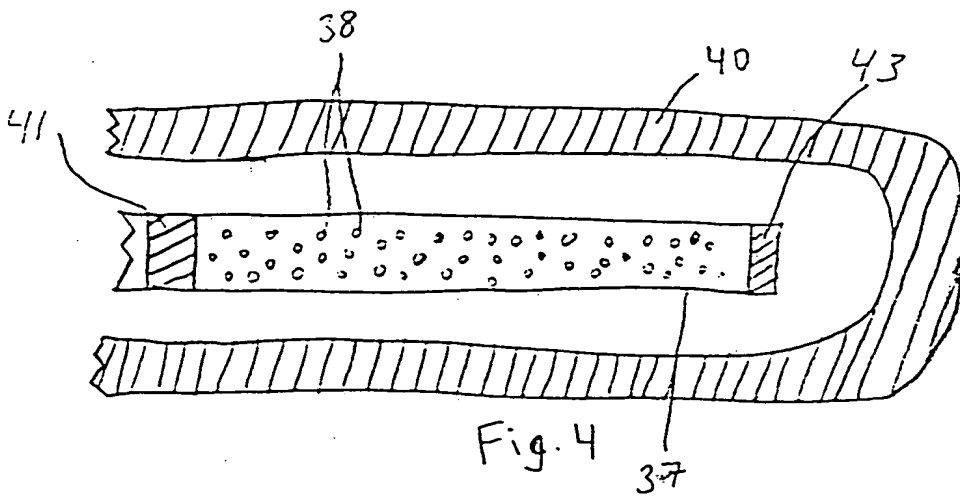
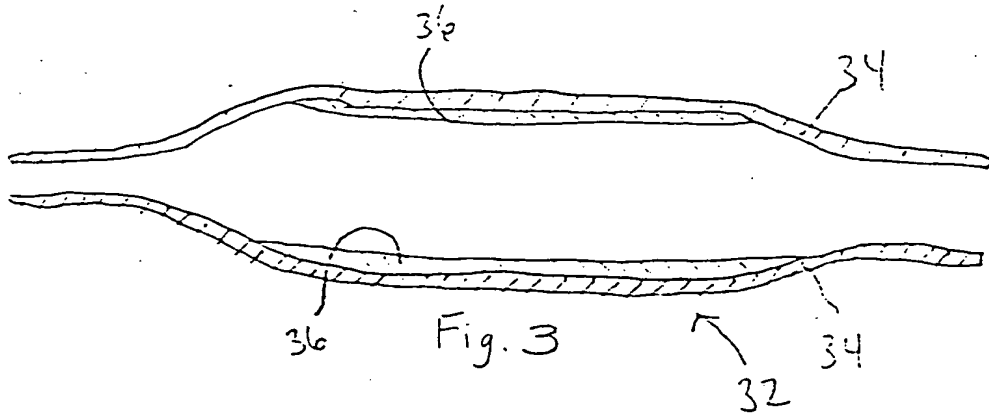
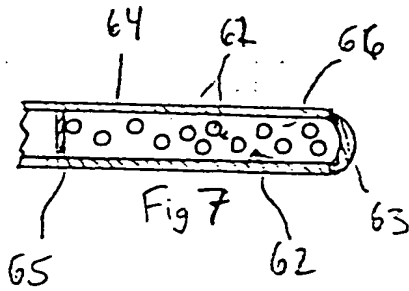
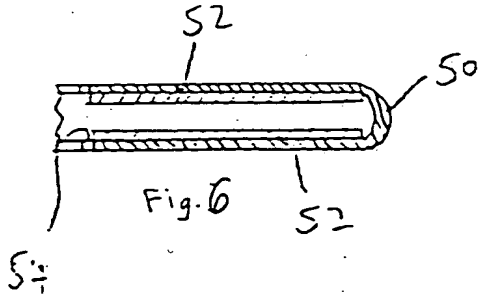
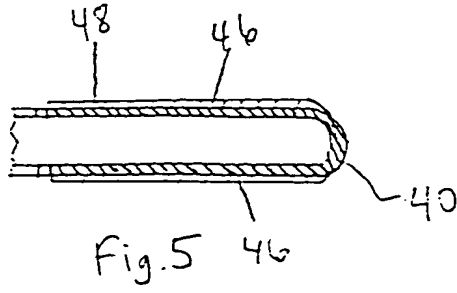

Fig. 2

TOP SECRET



FOR RELEASE



Patented

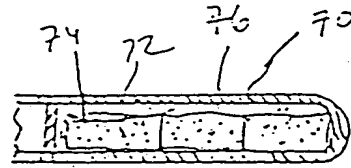

Fig. 8

TOP SECRET

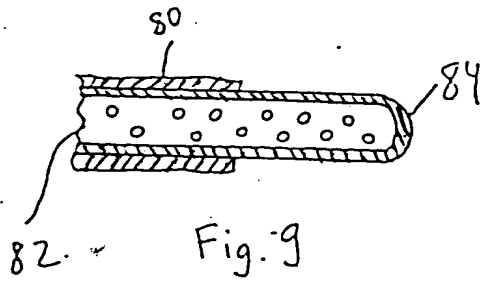

Fig. 9

FIG. 10

